

FESTA[®]

PROFESIONÁLNÍ X NÁŘADÍ



NOVINKY
2024

UTOOLS

otáčky
0 - 850 min⁻¹

BPM / přiklep
0 - 4500 / 6 J

výkon
1500 W

upínání
SDS+

hloubkový doraz



MAX Ø
beton - ø 32 mm
kov - ø 13 mm
dřevo - ø 40 mm



SDS+ upínací
hlava nástroje

přídavná rukojeť

systém pro omezení
vibrací

ergonomická
pogumovaná
rukojeť pro
pohodlný a
bezpečný úchop



2.0m

FESTA
POWER X TOOLS

SEKACÍ A VRTACÍ KLADIVO

Sada obsahuje:

- sekací kladivo
- přídavnou rukojeť
- hloubkový doraz
- montážní klíč
- kufr
- náhradní uhlíky
- nástroje SDS+:

Ø 8, 10, 12 x 160 mm

20 x 250 mm

14 x 250 mm



náhradní
uhlíky 2 ks - F28228



Č. p. Specifikace
F28225

otáčky
0 - 1350 min⁻¹

BPM/ přiklep
0 - 5500 / 2,8J

výkon
800 W

upínání
SDS+
ø 2 - 13 mm



MAX ø
beton - ø 26 mm
kov - ø 13 mm
dřevo - ø 30 mm



SDS+

ø 2 - 13 mm

2.0m

FESTA
POWER X TOOLS

VRTACÍ A SEKACÍ KLADIVO

Sada obsahuje:

- vrtací kladivo
- přídavnou rukojeť
- hloubkový doraz
- sklíčidlo ø 2 - 13 mm
- kufr
- vazelína
- náhradní uhlíky
- nástroje SDS+:

ø 6, 8, 10 x 160 mm

20 x 250 mm

14 x 250 mm



náhradní uhlíky 2 ks - F28223



č. p. Specifikace

F28220

otáčky
0 - 4500 min⁻¹

hmotnost
4,3 kg

výkon
1400 W

kotouč/ upínání
max ø 185mm/ ø 20 mm



ergonomická
pogumovaná
rukojet' pro
pohodlný a
bezpečný úchop



odsávání prachu
ø 35 mm

2.0m

boční vedení
- doraz 6 - 120 mm

FESTA
POWER X TOOLS

KOTOUČOVÁ PILA

Sada obsahuje:

- kotoučovou pilu
- doraz bočního vedení
- montážní inbus
- náhradní uhlíky
- kotouč ø 185 x 2,3/1,3 x 20 mm 24T (F22316)



1400W	230V ~ 50Hz	4500min ⁻¹	ø 20 185mm	90° 63mm	45° 42mm	KG 4.3
-------	----------------	-----------------------	---------------	-------------	-------------	-----------

náhradní
uhlíky 2 ks - F2B233



Č. p. Specifikace

F2B230

otáčky
11000 min⁻¹

hmotnost
2 kg

výkon
900 W

upínání
M14
max ø 125mm

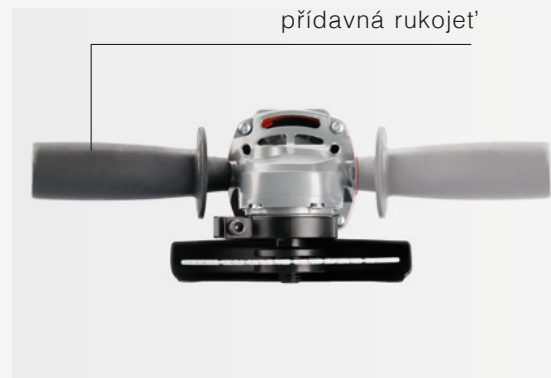

FESTA
POWER X TOOLS

ÚHLOVÁ BRUSKA

Sada obsahuje:

- úhlovou brusku
- kryt kotouče
- přídavnou rukojeť
- montážní klíč
- náhradní uhlíky

900W	230V ~ 50Hz	11000min ⁻¹	M14	max ø 125mm	2.0m RUBBER	KG 2.0				
------	----------------	------------------------	-----	-------------------	----------------	-----------	--	--	--	--

náhradní uhlíky 2 ks - F28213



Č. p. Specifikace
F28210

otáčky
6600 min⁻¹

hmotnost
5,8 kg

výkon
2400 W

upínání
M14
max ø 230 mm



ergonomická
pogumovaná
rukojeť pro
pohodlný a
bezpečný úchop

SOFT START

plynulý rozběh motoru

bezpečnostní pádlový spínač

2.0m

kryt kotouče



FESTA
POWER X TOOLS

ÚHLOVÁ BRUSKA

Sada obsahuje:

- úhlovou brusku
- kryt kotouče
- přídavnou rukojeť
- montážní klíč
- náhradní uhlíky



náhradní
uhlíky 2 ks - F28218



Č. p. Specifikace
F28215

max. tlak
8,2 bar

manometr
psi, bar,
kgf/cm², kPa

hadice
Ø 10,5x 600 mm

napětí
20 V

podsvícený display
manometru



ergonomická
pogumovaná
rukojeť pro
pohodlný a
bezpečný úchop

rychloupínací
spona na huštění
pneumatik

napájecí adaptér
do autozásuvky 3 m

hadice
Ø 10,5x 600 mm



adaptéry

LED osvětlení



FESTA
POWER X TOOLS

**KOMPRESOR AKU
SHARE
20V**

baterie*

FESTA
POWER X TOOLS
Li-ion
technology

2 Ah - F28080

4 Ah - F28081

8 Ah - F28083



Sada obsahuje:

- kompresor
- adaptér do autozásuvky
- 3x adaptéry pro nafukování

*baterie není součástí balení

0212024



č. p. Specifikace

F28075

1

max. nosnost
60 kg

vibrace
12 stupňů,
3500 - 8500 r/min

hmotnost
3 kg

napětí
20 V

svítící display



ergonomická
pogumovaná
rukojeť pro
pohodlný a
bezpečný úchop



přísavek Ø 125 mm

FESTA
POWER X TOOLS

VIBRÁTOR
S PŘÍSAVKOU NA DLAŽBU AKU
SHARE
20V

baterie*

FESTA
POWER X TOOLS
Li-ion
technology

2 Ah - F28080



4 Ah - F28081



8 Ah - F28083



Sada obsahuje:

- vibrační přísavek
- baterii 2,0 Ah (pouze **F36328**)
- nabíječku (pouze **F36328**)
- kufr

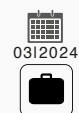

0312024

Č. p. Specifikace

F36328 s baterií 2Ah a nabíječkou

F36329 bez baterie a nabíječky

1

1

příjem
DAB+ / FM / BT

výkon
2x 15 W

voděodolnost
IPX54

napětí
20 V



USB pro nabíjení



napájení **SHARE 20V**



FM anténa

barevný display



vstup jack 3,5 mm

stereo reproduktory



napájení - adaptér 230V



*baterie není součástí balení



RÁDIOAKUDAB+ / FM / BT

- stereo
- příjem DAB+ / FM
- externí vstup Bluetooth V5.0 / AUX IN 3,5 mm jack
- voděodolnost IPX54
- 30 paměťových míst (30 pro DAB / 30 pro FM)
- USB pro nabíjení
- barevný display 2,4"
- výkon 2x 15 W
- 20 V / 1,3A
- napájecí adaptér

SHARE 20V

battery*



2 Ah - F28080



4 Ah - F28081



8 Ah - F28083



02/2024



rychlost
vytlačování
0-8,5 mm/s

hmotnost
2 kg

vytlačovací
síla
6000 N

napětí
20 V



velikost kartuše 310 ml

plynulá regulace
rychlosti vytlačování

ergonomická
pogumovaná
rukojeť pro
pohodlný a
bezpečný úchop



LED osvětlení

FESTA
POWER X TOOLS

PISTOLE VYTLAČOVACÍ AKU
SHARE
20V

battery*

FESTA
POWER X TOOLS
Li-ion
technology

2 Ah - F28080

4 Ah - F28081

8 Ah - F28083



*baterie není součástí balení



Č. p. Specifikace

F28060

1

indikátor
nabití
baterie



FESTA
POWER X TOOLS

BATERIE 20 V | 8,0 Ah
SHARE
20V

Li-ion
technology

20V 8,0 Ah Li-ion 1,0

0212024



Č. p. Specifikace

F28083

1



FESTA

KOTOUČ PILOVÝ DO DŘEVA
S SK PLÁTKY

pro F28230

FESTA
POWER X TOOLS



Č. p. Specifikace

F22316

Ø 185 mm x 2,3 mm / 1,3 x Ø 20 mm 24T

1

FESTA

SADA NÁSTROJŮ PRO OSCILAČNÍ BRUSKU

pro **F28045** **FESTA** POWER X TOOLS



4x

3x BI-METAL



1x SK5



Č.p. Specifikace

F24322



6

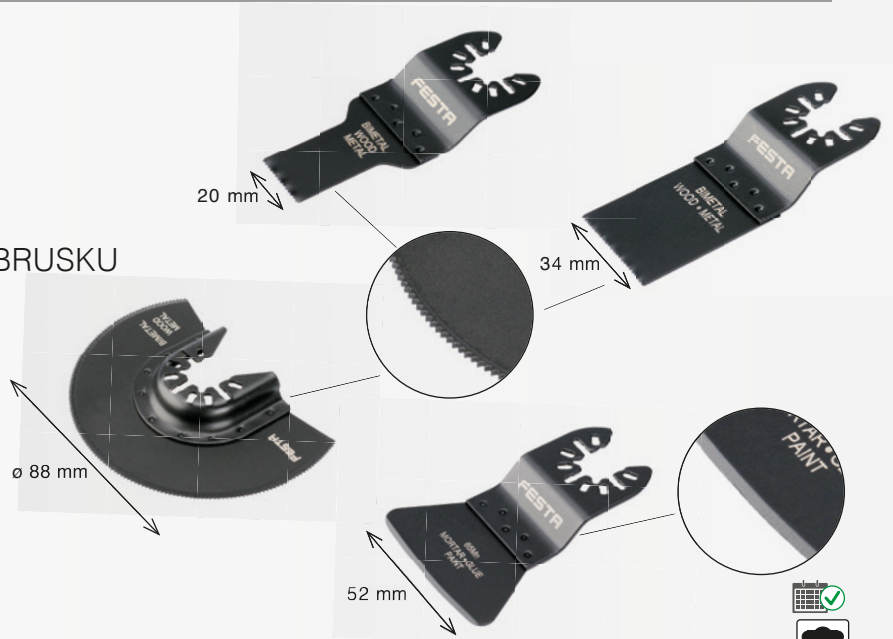

FESTA

SADA NÁSTROJŮ PRO OSCILAČNÍ BRUSKU

pro **F28045** **FESTA** POWER X TOOLS



4x

3x CARBIDE



1x



Č.p. Specifikace

F24321



6

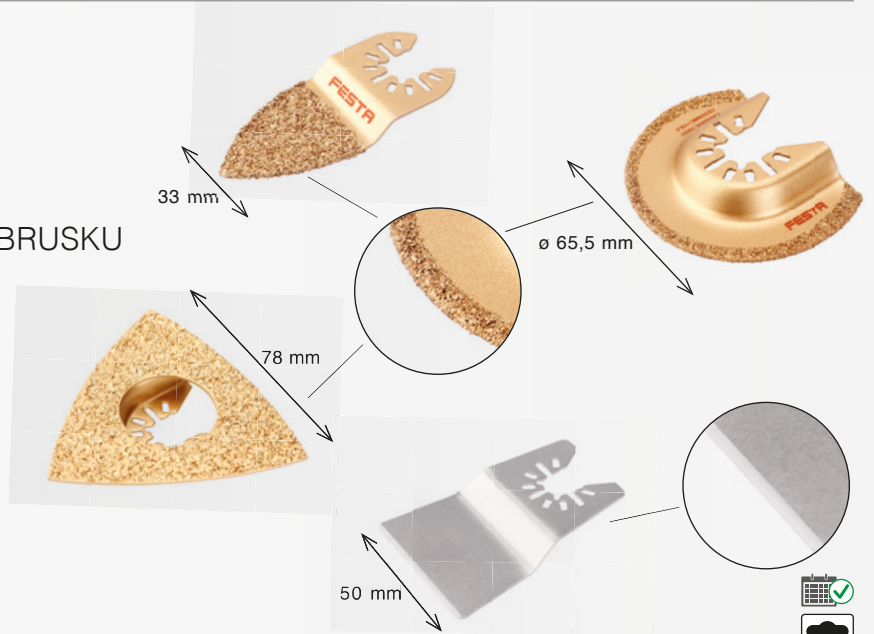

SADA NÁSTROJŮ PRO OSCILAČNÍ BRUSKU

pro **F28045** **FESTA** POWER X TOOLS



3x



Č.p. Specifikace

F24320



6

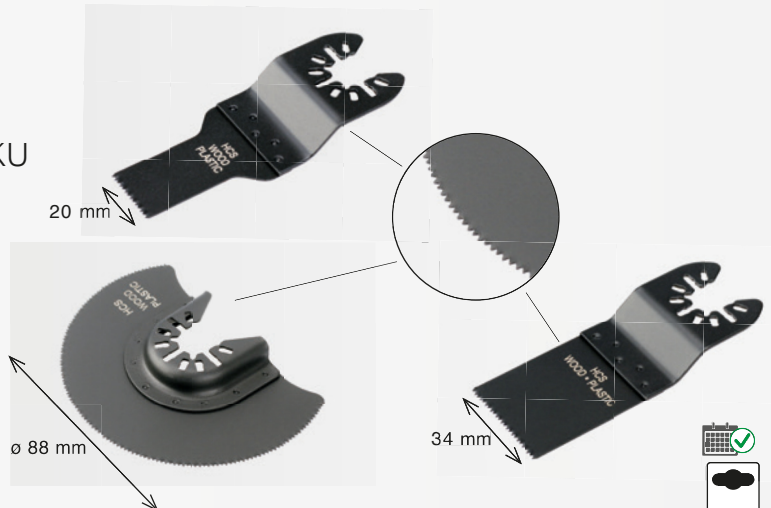

**FESTA****ZKOUŠEČKA NAPĚTÍ**

- AC / DC - 6 V, 12V, 24 V, 50 V, 120 V, 230 V, 400 V
- odolnost proti vniknutí vody IP54
- určení polarity
- CAT III 400 V



Č. p. Specifikace

F18428

02/2024



1

FESTA**MULTIMETR**

- měření napětí DC: 200 mV - 300 V
- měření napětí AC: 200 mV - 300 V
- měření proudu DC: 2000 μ A - 10 A
- měření odporu: 200 Ω - 2 M Ω
- kontrola baterií: 1,5V, 9 V
- indikace slabé baterie
- ochrana proti přetížení

- IEC61010
- CAT III 300 V
- certifikát GS
- napájení: 9 V baterie (6F22)
- rozměry: 70x128x28 mm
- hmotnost: 137 g (s baterií)
- příslušenství: testovací kabely



Č. p. Specifikace

F18429

03/2024



1

**FESTA****KLEŠTĚ ODIZOLOVÁVACÍ**

- 0,5 - 6 mm²
- délka 190 mm

Č. p. Specifikace

F17178

02/2024



1

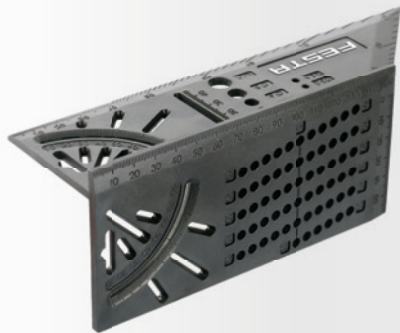

FESTA

ÚHELNÍK MULTIFUNKČNÍ 3D



Č. p. Specifikace
F14418



10



HORIZONT

STAHOVACÍ LAŤ - NASTAVITELNÁ

Č. p. Specifikace

F15893	65 - 100 cm
F15894	95 - 150 cm
F15895	145 - 235 cm



1

1

1



FESTA

ZNAČKOVAČ HLOUBKOVÝ, PERMANENTNÍ



0212024



Č. p. Specifikace

F13247	● červený	46
F13248	○ bílý	46



FESTA

KLEŠTĚ SIKO



Č. p. Specifikace

F16500	180 mm	0 - 35 mm	1
F16501	250 mm	0 - 45 mm	1
F16502	300 mm	0 - 60 mm	1



0212024

1

1

1

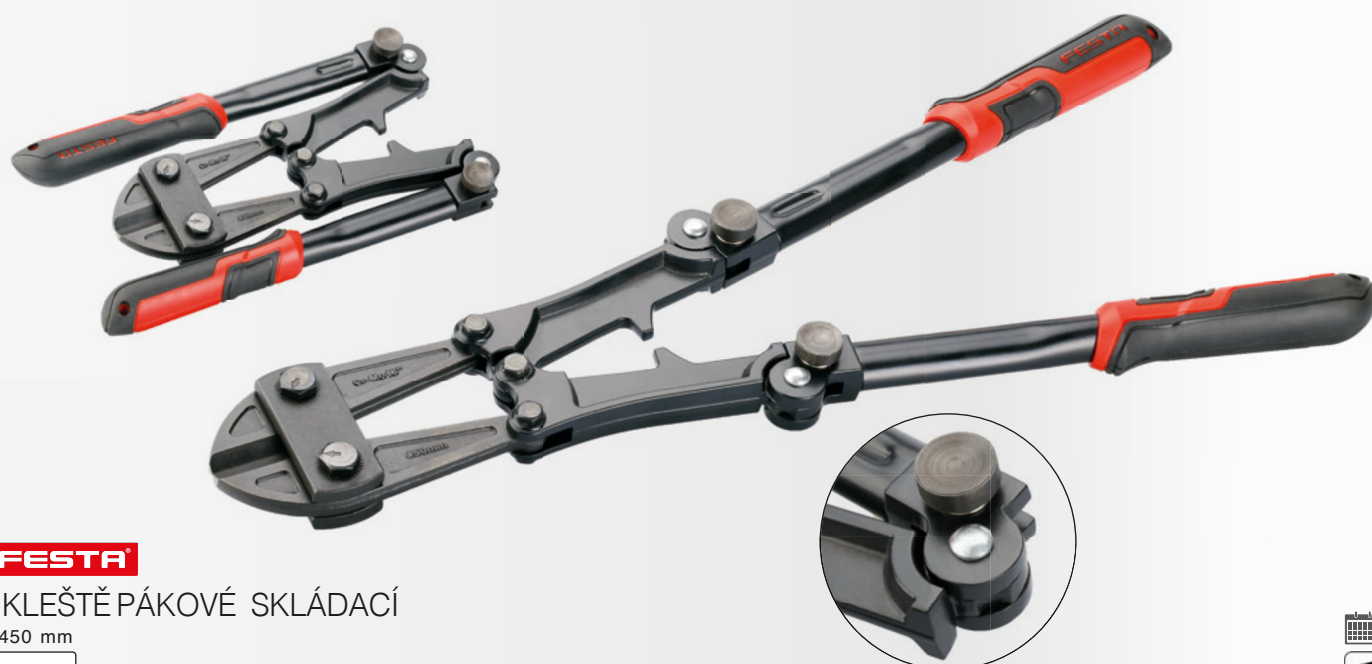
**FESTA****KLEŠTĚ PÁKOVÉ SKLÁDACÍ**

· 450 mm

Cr-Mo

Č. p. Specifikace

F17049

1

**F26730****F26731****FESTA****OHÝBAČKA TYČÍ, TŘMENŮ, DRÁTŮ**

Č. p. Specifikace

F26730 Ø 6 - 14 mm**F26731** Ø 5 - 8 mm

1

1

**OHÝBAČKA TYČÍ**

Č. p. Specifikace

F26735 max Ø 13 mm 56 cm

0212024



1



KLEŠTĚRYCHLOUPÍNACÍ

Č.p.	Specifikace	0212024
F17150	220 mm	1



KLEŠTĚRYCHLOUPÍNACÍ

Č.p.	Specifikace	0212024
F17151	220 mm	1

FESTA

**NŮŽKY NA PLECH
PRODLOUŽENÉ**



Cr-Mo HRC58-62



Č.p.	Specifikace	0212024
F17113	rovné 80 300 mm	6



FESTA

NÁSTAVEC NA STRÍHÁNÍ PLECHU



Č.p.	Specifikace	0212024
F20364		1



FESTA

ŘEZAČ TRUBEK

NOX ALU

ALU Cu PVC

Č. p.	Specifikace	
F16305	Ø 22 mm	10
F16306	Ø 15 mm	10



FESTA
INDUSTRY

BITTORZNÍ PH - 50 MM



Č. p.	specifikace	
F18715	PH1x 50 mm	1
F18716	PH2 x 50 mm	1
F18717	PH3 x 50 mm	1



FESTA
INDUSTRY

BITTORZNÍ PZ - 50 MM



Č. p.	specifikace	
F18710	PZ1x 50 mm	1
F18711	PZ2 x 50 mm	1
F18712	PZ3 x 50 mm	1



FESTA
INDUSTRY

BITTORZNÍ T - 50 MM



Č. p.	specifikace	
F18720	T10 x 50 mm	1
F18721	T15 x 50 mm	1
F18722	T20 x 50 mm	1
F18723	T25 x 50 mm	1
F18724	T30 x 50 mm	1
F18725	T40 x 50 mm	1

FESTA

SADA BITŮ

- bity 25 mm
- ⊖ S 3 · 4 · 5 · 6
 - ⊕ PH 0 · 1 · 2 · 3
 - ⊛ PZ 0 · 1 · 2 · 3
 - ⊙ H 3 · 4 · 5 · 6
 - ⊛ T 10 · 15 · 20 · 25 · 27 · 30 · 40
 - ⊛ TTa 10 · 15 · 20 · 25 · 27 · 30 · 40

nástavec na bity ○



Č. p.	Specifikace	
F18908		1





FESTA

NÁSTAVEC NÝTOVACÍ NA VRTAČKU

- Ø 2,4 mm
- Ø 3,2 mm
- Ø 4,0 mm
- Ø 4,8 mm



Cr-Mo

Č. p. Specifikace
F24008



1



FESTA

PISTOLE FOUKACÍ S DIGITÁLNÍM MANOMETREM

- 0 - 10 bar
- LCD display
- bar, kPa, Psi, kgf/cm²



Č. p. Specifikace
F48011 0 - 10bar



10



FESTA

PISTOLE OFUKOVACÍ S NÁSTAVCI

- 25 mm
- 90 mm
- 190 mm

Č. p. Specifikace
F48004



10

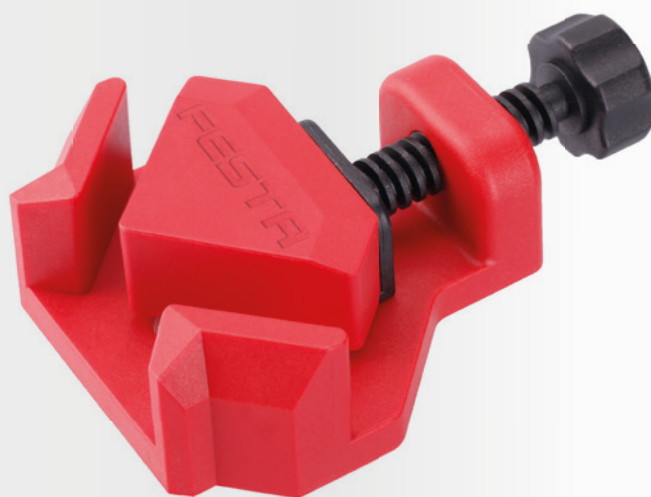

FESTA

SVĚRKÁROHOVÁ 90°



4x



0312024

Č. p. Specifikace

F23607 upínací síla - 250 N



1



FESTA

KOZA SKLÁDACÍ
· maximální nosnost: 400 kg

Č. p. Specifikace

F23658



0412024



1



**RUKAVICE NYLON
MÁČENÉ V LATEXOVÉ PĚŇĚ**

CE EN
388

Č. p.	specifikace
F50535	velikost 8"
F50536	velikost 9"



12



NŮŽ BEZPEČNOSTNÍ

Č. p.	Specifikace
F16044	



20

systém pro odlamování čepele



NŮŽ ODLAMOvacÍ

protiskluzové pogumování

Č. p.	Specifikace
F16099	18 mm



1



BROUSEK MULTIFUNKČNÍ 15v1



	30° Anvil	
	45° Anvil	
	50° Anvil	
	23° Bypass	
	35° Bypass	
	65° Bypass	
	Debur Tool	







Č. p.	Specifikace
F45073	



1

SADA VRTÁKŮ A BITŮ

vrtáky do dřeva Ø 3 · 4 · 5 · 6 · 8 mm
 vrtáky do kovu Ø 1 · 1,5 · 2 · 2,5 · 3 · 3,5 · 4 · 4,5 · 5 · 5,5 · 6 · 7 · 8 · 10 mm
 vrtáky do zdi Ø 4 · 5 · 6 · 8 · 10 mm
 vrtáky do dřeva ploché Ø 16 · 22 · 25 mm
 vykružovací pily Ø 32 · 38 · 44 · 54 mm
 hloubkové dorazy Ø 6 · 8 · 10 mm
 důlčik
 měrka na měření průměru vrtáku

bity 25 mm  S 3 · 4 · 4 · 5 · 5 · 6 · 6 · 7
 PH 0 · 0 · 1 · 1 · 2 · 2 · 2 · 3 · 3
 PZ 0 · 0 · 1 · 1 · 2 · 2 · 2 · 3 · 3
 H 2 · 2,5 · 3 · 3,5 · 4 · 5 · 6
 T 10 · 15 · 20 · 25 · 27 · 30 · 40

bity 50 mm  S 4 · 5 · 6 · 6
 PH 1 · 2 · 2 · 3
 PZ 1 · 2 · 2 · 3

šroubovací nástavce  4 · 5 · 6 · 7 · 8 · 9 · 10 · 13 mm
 odjehlovací fréza
 nástavec na bity



100x

Č. p. Specifikace

F20340



1

FESTA

PILA JAPONSKÁ



Č. p. Specifikace

F24134 250 mm 0,5 mm



10



FESTA

RUKOJEŽ PRO PILOVÉ PLÁTKY

· rukojeť + 2x pilový plátek
 · pro pilové plátky do pily ocasky



Č. p. Specifikace

F24325



1



SADA VYKRUŽOVACÍCH DIAMANTOVÝCH KORUNEK

- Ø 6 mm
- Ø 8 mm
- Ø 25 mm
- Ø 35 mm
- Ø 40 mm
- Ø 50 mm
- Ø 68 mm

7x M4



- keramické obklady a dlažba
- mramor
- žula



- použití bez chlazení vodou

Č. p. Specifikace

F24651



1



SADA VYKRUŽOVACÍCH DIAMANTOVÝCH KORUNEK

- Ø 6 mm
- Ø 8 mm
- Ø 10 mm
- Ø 12 mm
- Ø 20 mm
- Ø 28 mm
- Ø 35 mm
- Ø 45 mm
- Ø 55 mm
- Ø 68 mm

- kotouč řezný / brusný Ø 125 mm x 2,0 mm Ø 22,2 mm
- kotouč řezný Ø 125 mm x 1,2 mm Ø 22,2 mm
- kuželová korunka brusná Ø 0 - 50 mm
- diamantová brusná houba 90 x 55 mm P60

13x M4



- keramické obklady a dlažba
- mramor
- žula



- použití bez chlazení vodou

Č. p. Specifikace

F24652



1



KORUNKA VYKRUŽOVACÍ DIAMANTOVÁ

M14



- keramické obklady a dlažba
- mramor
- žula



- použití bez chlazení vodou



Č. p.	Specifikace	úchyt	
F24620	Ø 6 mm	M14	1
F24621	Ø 8 mm	M14	1
F24622	Ø 10 mm	M14	1
F24623	Ø 12 mm	M14	1
F24624	Ø 14 mm	M14	1
F24627	Ø 20 mm	M14	1
F24630	Ø 28 mm	M14	1
F24633	Ø 35 mm	M14	1
F24636	Ø 45 mm	M14	1
F24638	Ø 55 mm	M14	1
F24640	Ø 68 mm	M14	1
F24643	Ø 75 mm	M14	1



KORUNKA BRUSNÁ DIAMANTOVÁ

M14



- keramické obklady a dlažba
- mramor
- žula



- použití bez chlazení vodou



Č. p.	Specifikace	
F24797	Ø 6 - 50 mm	1
F24799	Ø 10 - 50 mm	1



KORUNKA VYKRUŽOVACÍ A BRUSNÁ DIAMANTOVÁ

M14



- keramické obklady a dlažba
- mramor
- žula



- použití bez chlazení vodou



Č. p.	Specifikace	
F24777	Ø 2 - 75 mm	1





FESTA

KORUNKA VYKRUŽOVACÍ DIAMANTOVÁ

M14



- keramické obklady a dlažba
- mramor
- žula



- použití bez chlazení vodou



Č. p.	Specifikace	úchyt	
F24677	Ø102 mm	M14	1
F24678	Ø 125 mm	M14	1

FESTA

VRTÁKY NA SKLO A KERAMIKU, SADA

- Ø 4 mm
- Ø 5 mm
- Ø 6 mm
- Ø 8 mm
- Ø 10 mm

5x



- keramické obklady a dlažba
- mramor
- žula



- použití bez chlazení vodou



Č. p.	Specifikace	
F24734		1



FESTA

**CHLADICÍ VOSK
NA DIAMANTOVÉ KORUNKY**

Č. p.	Specifikace	
F24710	30 ml	1



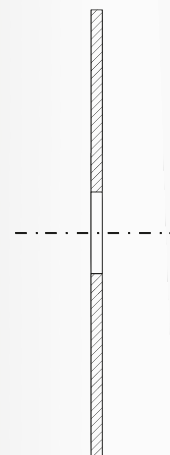

KOTOUČ ŘEZNÝ / BRUSNÝ - DIAMANTOVÝ



- keramické obklady a dlažba
- mramor
- žula



- použití bez chlazení vodou



Č. p.	Specifikace		
F21230	Ø 115mm x 1,8mm	Ø 22,2 mm	1
F21231	Ø 125 mm x 2,0 mm	Ø 22,2 mm	1



KOTOUČ ŘEZNÝ - DIAMANTOVÝ - TURBO EXTREME



- železobeton
- keramické obklady a dlažba
- mramor
- žula



- použití bez chlazení vodou

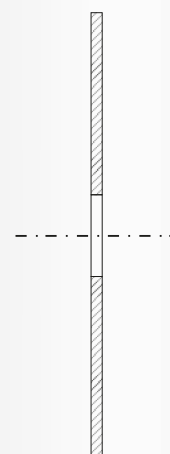
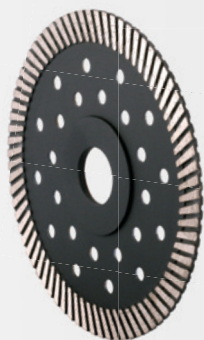

Č. p.	Specifikace		
F21205	Ø 125 mm x 2,0 mm	Ø 22,2 mm	1
F21209	Ø 230 mm x 2,6 mm	Ø 22,2 mm	1



KOTOUČ ŘEZNÝ



- keramické obklady a dlažba
- mramor
- žula



- použití bez chlazení vodou



Č. p.	Specifikace		
F21235	Ø 125 mm x 1,2x 8 mm	Ø 22,2 mm	1

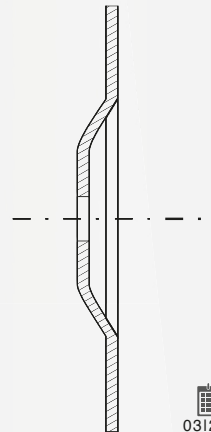
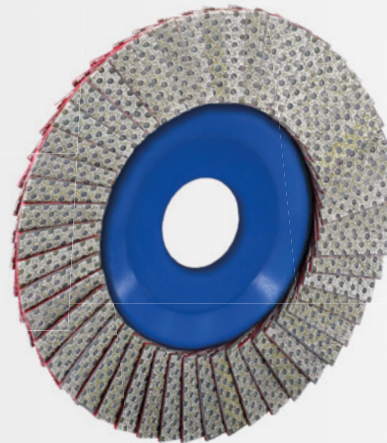
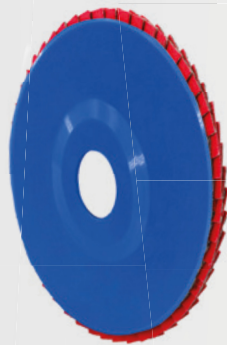

FESTA

**KOTOUČ LAMELOVÝ
- DIAMANTOVÝ**

· pro zábrus dlažeb



- keramické obklady a dlažba
- mramor
- žula



· použití bez chlazení vodou

03/2024



Č.p.	Specifikace			
F24647	Ø 115mm	Ø 22,2 mm	P60	1
F24648	Ø 115mm	Ø 22,2 mm	P120	1
F24649	Ø 115mm	Ø 22,2 mm	P200	1

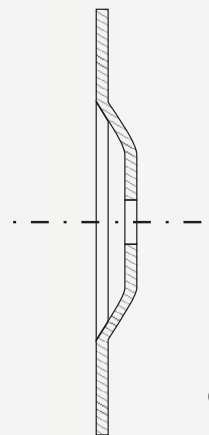

FESTA

KOTOUČ BRUSNÝ



Č.p.	Specifikace			
F21435	Ø 115mm	Ø 22,2 mm		1
F21436	Ø 125 mm	Ø 22,2 mm		1
F21437	Ø 150 mm	Ø 22,2 mm		1

01/2024



20 mm

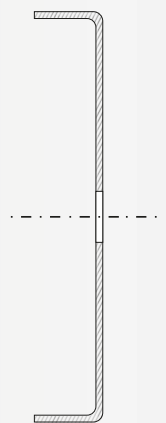

FESTA

KOTOUČ RAŠPLOVÝ



Č.p.	Specifikace			
F21806	Ø 125 mm	Ø 22,2 mm		10

01/2024



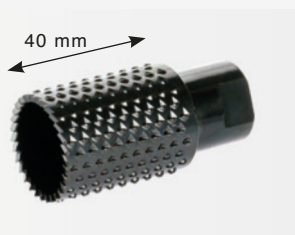

FESTA

RAŠPLEVÁLCOVÁ

M14



Č.p. Specifikace
F21807 Ø 30 mm / 60 mm

1



FESTA

RAŠPLE KULOVÁ

M14



Č.p. Specifikace
F21808 Ø 30 mm / 105 mm

10



FESTA

VRATIDLO STAVITELNÉ

DIN 1814



Č.p. specifikace
F20394 M5 - M20

10



ORGANIZÉR



Č.p. Specifikace
F55650 375 x 290 x 67 mm



0212024

1



FESTA

STĚRKA KOUTOVÁ, NEREZ

NOX



Č.p. Specifikace

F31517

10

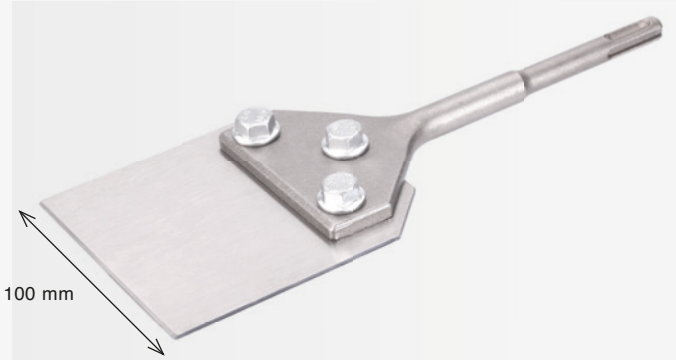

FESTA

SEKÁČ SDS +

SDS+



Č.p. Specifikace

F20996 250 x 100 mm

1



STĚRKY SILIKONOVÉ, SADA

4x



Č.p. Specifikace

F37052

1

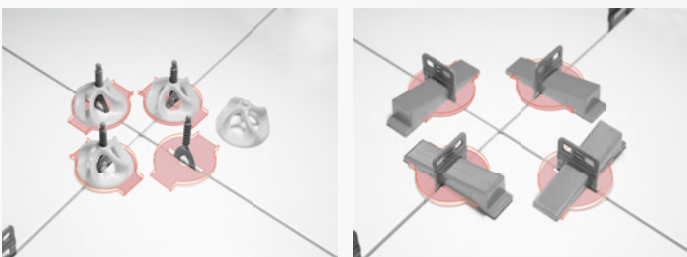

RUČNÍ PĚCHOVADLO



0212024

Č.p. Specifikace

F26740 12 kg

1



NIVELYS
LEVELING SYSTEMS **FESTA**

PODLOŽKA OCHRANNÁ
POD NIVELAČNÍ SYSTÉM

100x



0112024



Č.p. Specifikace

F37192

1

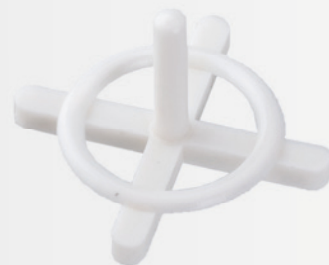

FESTA

KŘÍŽKY NA OBKLADY A DLAŽBU
S ÚCHYTEM

100x



Č.p. specifikace

F37285 1,5 mm 100

F37286 2 mm 100

F37287 2,5 mm 100

F37288 3 mm 100

F37289 4 mm 100



pro řezný kotouč Ø 125 mm

čerpadlo
pro chlazení vodou



chlazení vodou

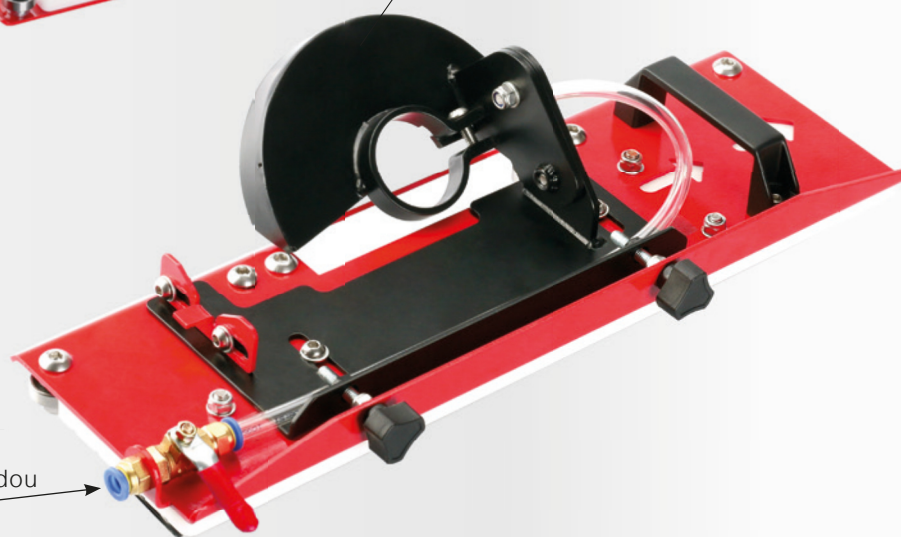

přípojka pro odsávání prachu



FESTA

VODICÍ LIŠTA PRO ŘZÁNÍ DLAŽBY 45°

Sada obsahuje:

- vodící lištu
- čerpadlo pro vodní chlazení
- náhradní hadičku pro vodní chlazení
- přepravní brašnu

Č.p. Specifikace

F24680

0212024



1



KLÍČ PRO ODVZDUŠNĚNÍ TOPENÍ

2x

Č.p. Specifikace
F17454 5 x 5 mm



1

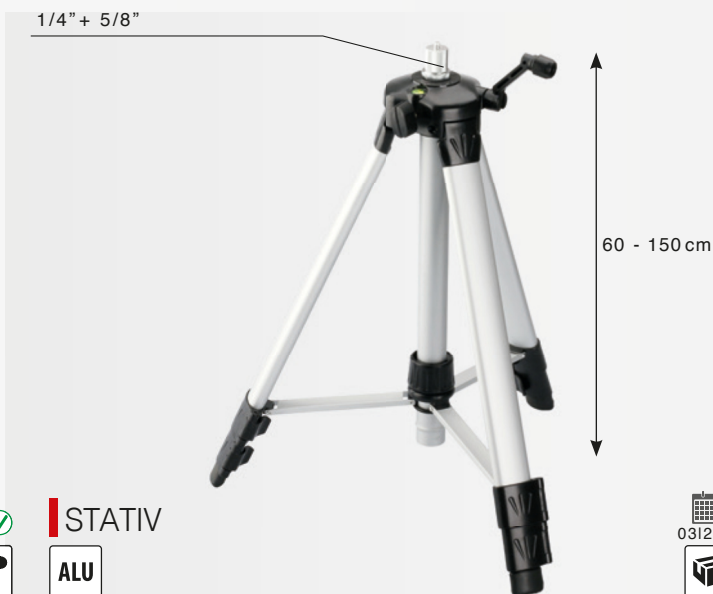

STATIV

ALU

Č.p. Specifikace
F26219 60 - 150 cm 1/4\"/>



1



FESTA

NÁSTAVEC NA ODSÁVÁNÍ PRACHU

Č.p. Specifikace
F28267 max. 70 mm

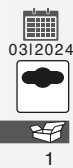

1



GRILOVACÍ VIDLICE - TELESKOPIČKÁ

NOX

Č.p. Specifikace
F43094



1



DRŽÁK NA KLADIVA A PALICE

Zn

No. specifications
FB1188 max 2 kg



1

GRAFICKÉ SYMBOLY POUŽITÉ V KATALOGU

PIKTOGRAMY SPECIFIKACE PRODUKTŮ



SPECIFIKACE POUŽITÍ

- dřevo
- keramika
- plasty
- hliník
- měď
- kámen
- sklo
- zdivo
- papír
- ocel
- kompozit
- obklady
- nerezová ocel
- omítka
- dřevo se šrouby, hřebíky
- sádrokarton
- pro vrtání do materiálů s pevností v tahu do ...

- S2** · funkční části z vysoce legované nástrojové oceli S2
- HSS** · funkční části vyrobeny z rychlořezné oceli
- Cr-Mo** · funkční části z chrom-molybdenové oceli
- QV** · funkční části z chrom-vanadové oceli
- NOX** · funkční části z nerezavějící oceli
- NYLON** · nylonová rukojeť
- TEFLON** · teflonový povrch
- Zn** · zinkováno
- TiN** · povrch potažen nitridem titanu
- HRC5861** · tvrdost materiálu funkčních částí podle Rockwella
- 40% PES** · složení materiálu - obsahuje 40%polyesteru
- PES** · složení materiálu - vyrobeno z polyesteru
- DIAMANT** · diamantová zrna na povrchu funkčních částí
- MAGNETICKÉ** · magnetické

- SDS+** **SDS MAX** **M14** · způsob uchycení
- 72T** **36T** · počet zubů ráčny
- 1/2"** **3/4"** **1/4"** · velikost uchycení
- 27dB** · údaj o výši ochrany sluchu
- DIN3113** **IP 54** · splňuje uvedenou normu
- 32x** · počet produktů v sadě
- II. class** **III. class** · splňuje uvedenou třídu přesnosti
- SNOW** · vhodné do chladného počasí
- ERGO HANDLE** · ergonomická rukojeť
- HOBBY** · pro hobby použití
- 2x AAA** · počet a typ baterií
- UV STABLE** · odolné proti UV záření
- RUBBER ENDS** · nárazuvzdorné gumové koncovky



SPECIFIKACE BALENÍ

- KRABICE** · baleno v krabici
- ZÁVĚSEM** · balení se závěsem
- MOQ 12** · minimální objednatelné množství
- 5** · počet kusů v balení

SPECIFIKACE PRODUKTŮ VODNÍHO PROGRAMU

- volitelný tvar proudu vody
- minimální a maximální tlak
- maximální průtok vody
- zavlažovaná plocha
- velikost závitů pro připojení adaptéru
- průměr hadice pro připojení do rychlospojky



2024



PROFESIONÁLNÍ  NÁŘADÍ



festatools



#festatools



festatools

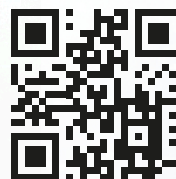

www.festa.tools

HORIZONT.

FESTA
POWER X TOOLS

FESTA
AQUATIC

KDS KOMELON.

ROSA

Stahlberg

Lescha SUPER PRO

